

Strip heaters

An excellent choice for surface contact heating

DESCRIPTION

Strip heaters are used for heat transfer by conduction towards surfaces or by convection to heat liquids, air or gases. Strip heater sheaths are constructed in stainless steel. The heaters have ceramic cores for high temperature applications which isolate the Ni-Cr spiral coil and filling with magnesium oxide guaranteeing a better thermic exchange.

APPLICATIONS

Vacuum Packaging machines
Food warming

Autoclaves
Flat surfaces for presses

Tank and plate heating
Ovens

SPECIFICATIONS

Core dimensions: 10 x 40 mm
Sheath Material: stainless steel

Maximum Watt Density: 6.0 W/cm²
Maximum Operating Temperatures: 450°C
Possible electric connections: all monophasic voltages

Terminations Type: Off set terminations, Parallel terminals, terminal at each end. Strip heaters are also available with flexible cables.

Strip heaters can also be provided with mounting holes for an optimum security fixing.

Strip heaters are available in a full range of sizes, wattages and voltages. Please do not hesitate to contact us for application or product assistance.

Strip Heater characteristics

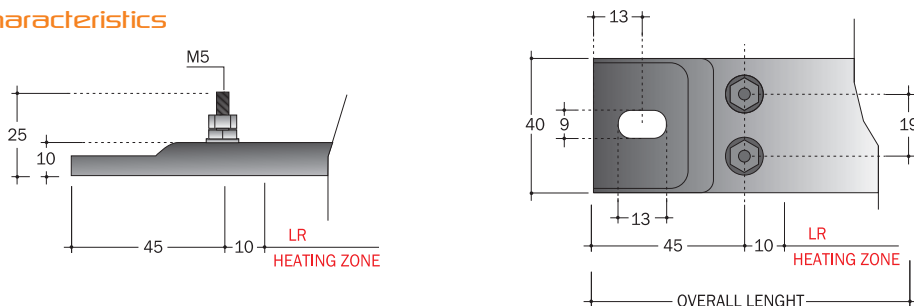

Terminations Type

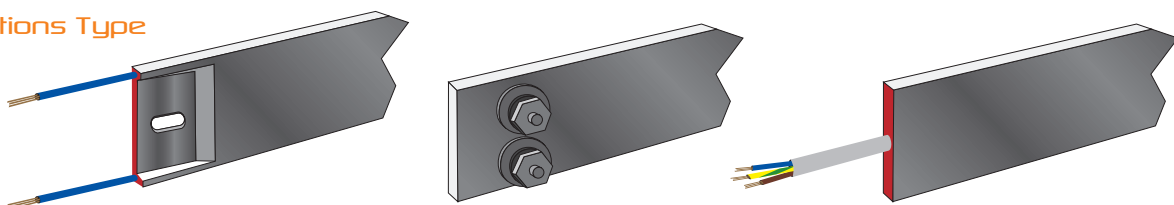

available in version IP65

Strip heaters

Termination Options

Standard Version

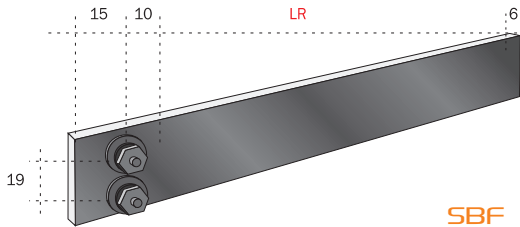

SBF

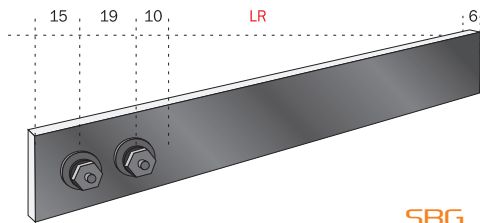

SBG

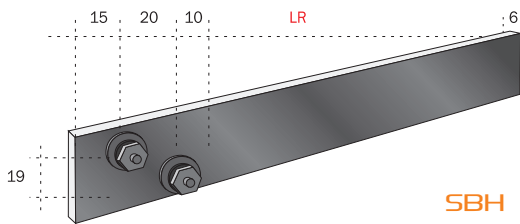

SBH

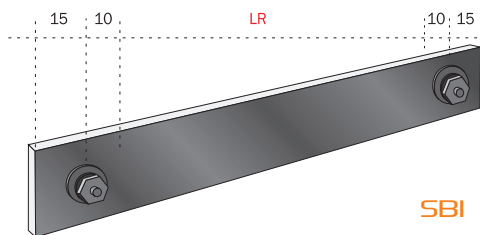

SBI

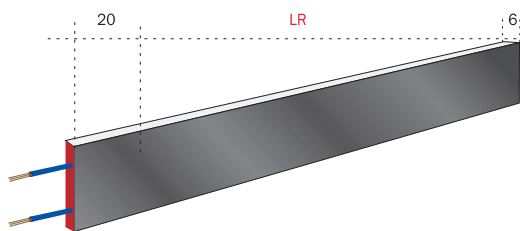

SBJ

Version with Mounting Holes

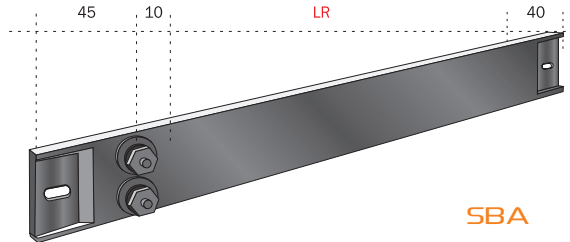

SBA

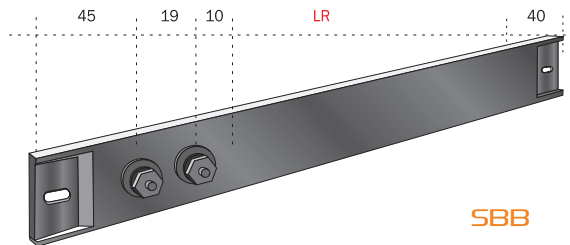

SBB

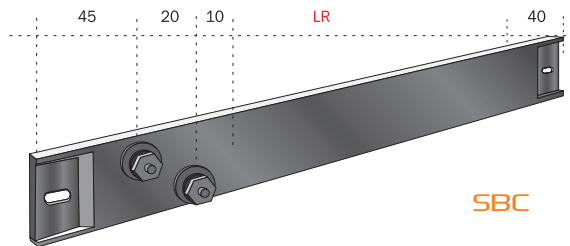

SBC

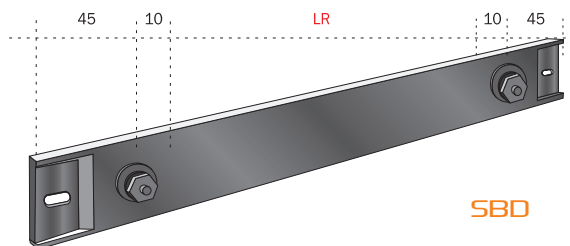

SBD

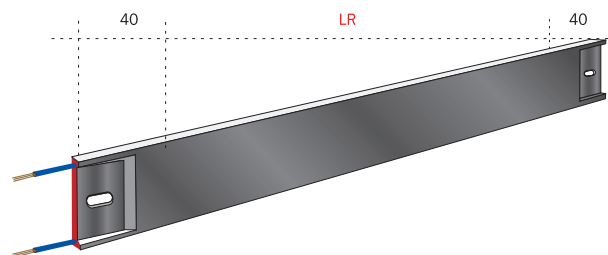

SBE

Vertical Alignment
Terminals at one end

Horizontal Alignment
Terminals at one end

Offset
Terminals at one end

One terminal
at each end

Flexible high temperature
insulated leads at one end