

“SMART Program”

Electronic control for towel radiators

SMART PROGRAM is an electronic clock thermostat for electric towel heaters based on fluid heat transfer.

SMART PROGRAM controls the towel radiator temperature by means of an internal sensor.

The **SMART** series has the heating element attached to the thermostat.

The symmetry of the device enables both right and left side coupling to the towel heater. The device can be exclusively controlled through the dedicated remote control. The remote control is provided with a bracket for anchoring it to a.

Twelve different types of electric resistance are

available, from 100W to 1000W. The device is available in white and chromed colours, and it can even be mounted on towel heaters with mixed operation.



Operative modes:

Comfort, Antifreeze, Chrono, Boost 2h, ECO, Key lock.

Available colours:

- White
- Chromed

SMART Program is a certified product: 

SMART Program is compliant to the following standards:

-Eco-design Directive for Energy-using Products, 2005/32/EC (<0,5W).

-EN 60335-1:2012+A11:2014

-EN 60335-2-43:2003+A1:2006+A2:2008

-EN 61000-3-2:2014 -EN61000-3-3:2013 -EN 62233:2008

-EN 55014-1:2006+A1:2009+A2:2011 -EN 55014-2:1997+A1:2001+A2:2008

“SMART Program ”

Electronic control for towel radiators

TECHNICAL CHARACTERISTICS OF THE THERMOSTAT

Product	Electronic control for electric towel radiators
Applications	Towel radiators
Insulation class	Class I, Class II
IP level	IP44
Maximum power	See table below
Supply voltage	230VAC 50Hz
Size	See picture below
Warranty	2 years
Standards	-EN 60335-1:2012+A11:2014 -EN 60335-2-30:2009+A11:2012 -EN 60335-2-43:2003+A1:2006+A2:2008 -EN 61000-3-2:2014 -EN61000-3-3:2013 -EN 62233:2008 -EN 55014-1:2006+A1:2009+A2:2011 -EN 55014-2:1997+A1:2001+A2:2008
Approval mark	CE
Case	ABS+PC-V0
Environmental directives	WEEE, RoHS
Operative modes	Comfort, Antifreeze, Stand-by, Chrono, Boost 2h, ECO, Key lock
Thermostat status light indicators	Mode LED (red, green, amber) On/Stand-by LED (red, green, amber)
Connection to mains	3 cables (neutral, earth, live); 2 cables (live, neutral); Swiss, UK, Italian plugs; Schuko plug;
Available colours	White (RAL 9016); Chromed.

Power	(W)	100	200	250	300	400	500	600	700	750	800	900	1000
Length (Heating element) class II	(mm)	350	350	350	350	370	410	465	520	560	600	670	730
Length (Heating element) class I	(mm)	350	350	370	370	430	450	560	630	700	700	760	830

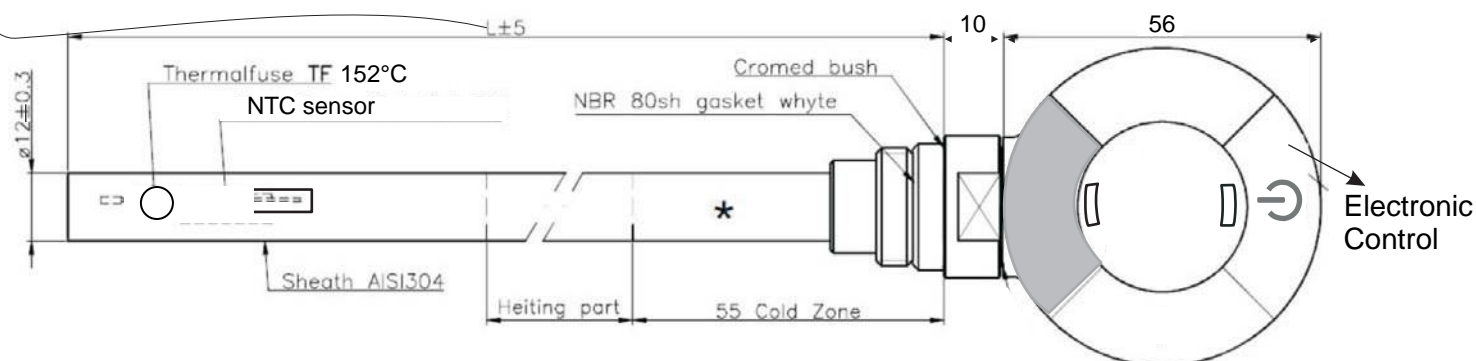

“SMART Program ”

Electronic control for towel radiators

TECHNICAL CHARACTERISTICS OF THE REMOTE CONTROL

Product	Remote control for electronic control
Applications	Smart Program thermostat
Colour	White
Display	LCD
Keyboard	7 keys
Temperature selection	Digital
Operational mode selection	Digital
Selectable operational modes and functions	Comfort, Antifreeze, Stand-by, Chrono, Boost 2h, ECO, Key lock
Selectable temperature range	30°C ÷ 70°C with 5°C steps.
Operative temperature range	-10°C ÷ +40°C
Battery	2 x 1,5V - AAA type
Signal transmission	Infrared (2 transmitters)
Size	100 x 42 x 27mm(H x L x W)
Anchoring	Wall anchoring through dedicated bracket.
Warranty	2 years

“*SMART Program*”

Electronic control for towel radiators

WARNING
RISK OF ELECTRIC SHOCK!
Disconnect power supply before proceeding with installation.

Preserve with care the present instruction sheet and read carefully before using the device.

- The present device has been designed for exclusive use on a towel radiator.
- The thermostat is designed for heating the liquid contained inside a towel radiator in combination with a heating element. Any other use is forbidden.
- Before using, carefully ensure that the line voltage is the same as that specified for the device (see technical specifications).
- Only use heating elements compatible with the type of used towel radiator.
- Disconnect the power supply before cleaning or before performing maintenance of the product.
- In case of damage of the power supply cable shut down the device and do not tamper with it. The damaged power supply cables can be replaced exclusively by the manufacturer or by an authorized service center. Failure to comply with the above rules could lead to compromised system safety and void the warranty.
- Store and transport the heating element exclusively in the protecting packaging.
- Replacement of the heating element can be done exclusively by the product manufacturer.
- Children aged under 8 years old and people with reduced physical, sensory or mental abilities, can use the device only under supervision. Children should not play with the device.
- Cleaning and maintenance meant to be carried out by the user should not be done by children without supervision.

Rev. 2 – giugno 2017

“SMART Program ”

Electronic control for towel radiators

Installation Guide

To be used by installer only

- Disconnect the device from power supply before proceeding with installation.
- Protect the device with a 30mA RCD circuit breaker.

- 1) Insert the heating element in the threaded opening located on the bottom part of the radiator.
- 2) Securely fasten the electric resistance to the body of the towel radiator with a 22mm wrench.
- 3) The special sheath ensures a secure mounting and eventually allows a slight supplemental torsion to perfectly align the thermostat with the radiator.
- 4) Tilt the radiator as in fig. 3, making sure that the opening on top of the radiator is located on the highest side. **WARNING.** Do not lean the radiator on the electronic control!
- 5) Fill the radiator with the specific liquid.
- 6) Put the radiator back in vertical position and check the internal level of the liquid (fig. 4).
- 7) Ensure a proper fastening of the heating element in the radiator.
- 8) Connect the device to mains and start heating (the top opening of the radiator must remain open!).
- 9) Set the maximal temperature and check the level of the internal liquid.
 - Due to thermal expansion the liquid could brim over the radiator.
 - Remove the exceeding liquid (be careful to avoid burns!) in order to keep the thermostat dry and avoid the liquid reaching the border.
- 10) When the level of the liquid stops growing, wait for additional 5 minutes then stop heating.
- 11) If necessary, top up the radiator before the liquid cools down (keep the temperature of the internal liquid checked all the time).
- 12) Close the top opening of the radiator with the appropriate cap.
- 13) Hook the radiator to the wall.
- 14) Connect the device to the mains. For models having no plug it is necessary to install a suitable omnipolar disconnection switch ensuring complete disconnection in case of category III overvoltage (that means a switch with at least 3 mm of space between open contacts).

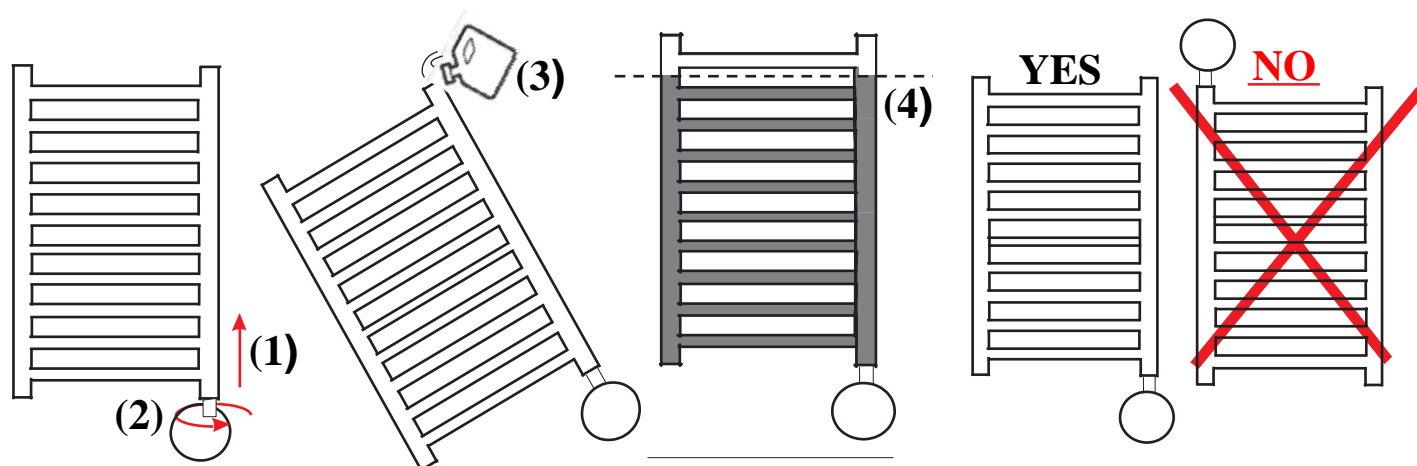

“SMART Program ”

Electronic control for towel radiators

Anchoring the remote control to the wall

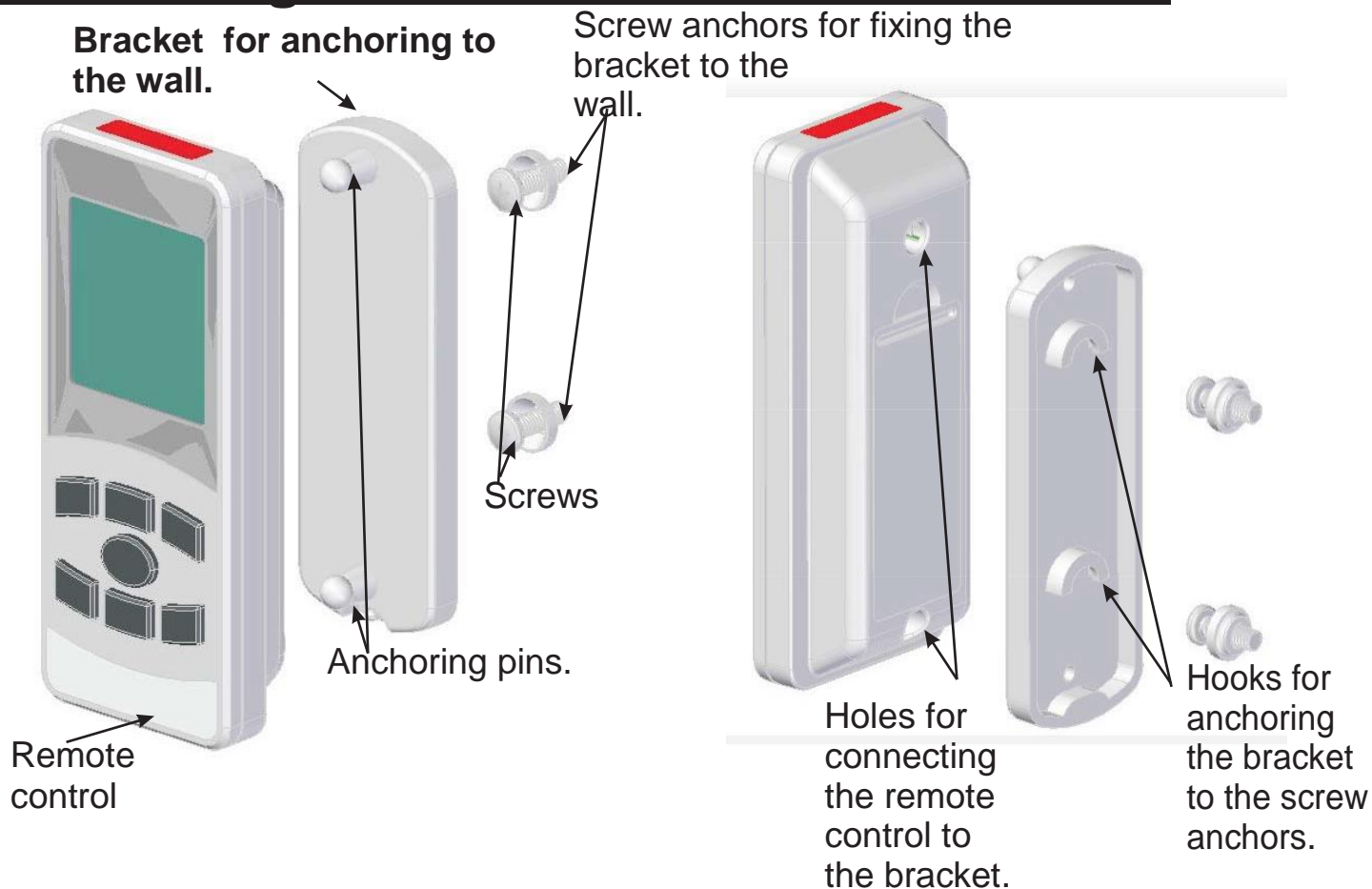

REMOTE CONTROL CHARACTERISTICS



“SMART Program”

Electronic control for towel radiators

User Guide

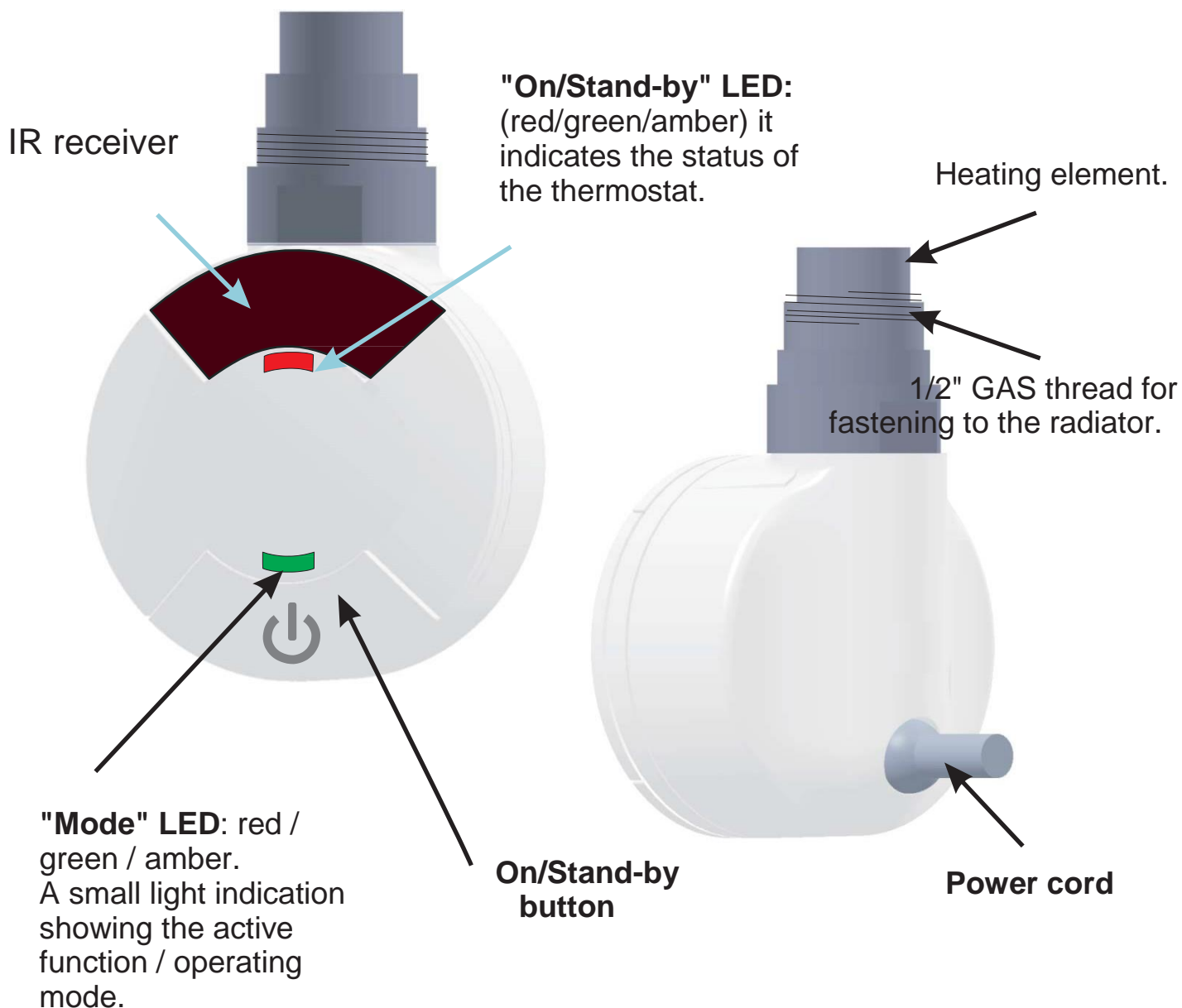

“SMART Program”

Electronic control for towel radiators

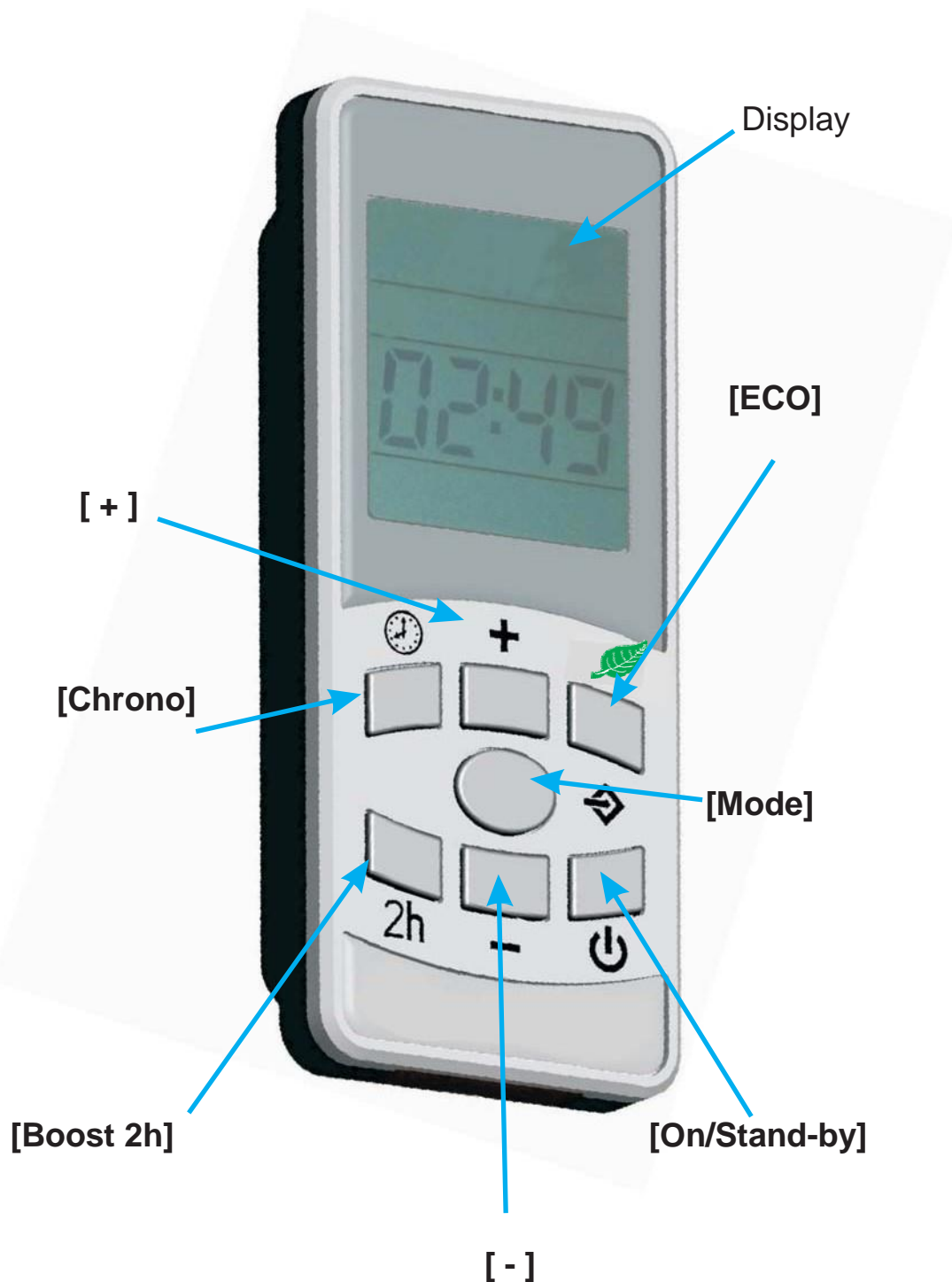

“SMART Program ”

Electronic control for towel radiators

User guide

Press the [On/Stand-by] button on the remote control or on the thermostat to turn on the device or to switch to "Stand-by" mode



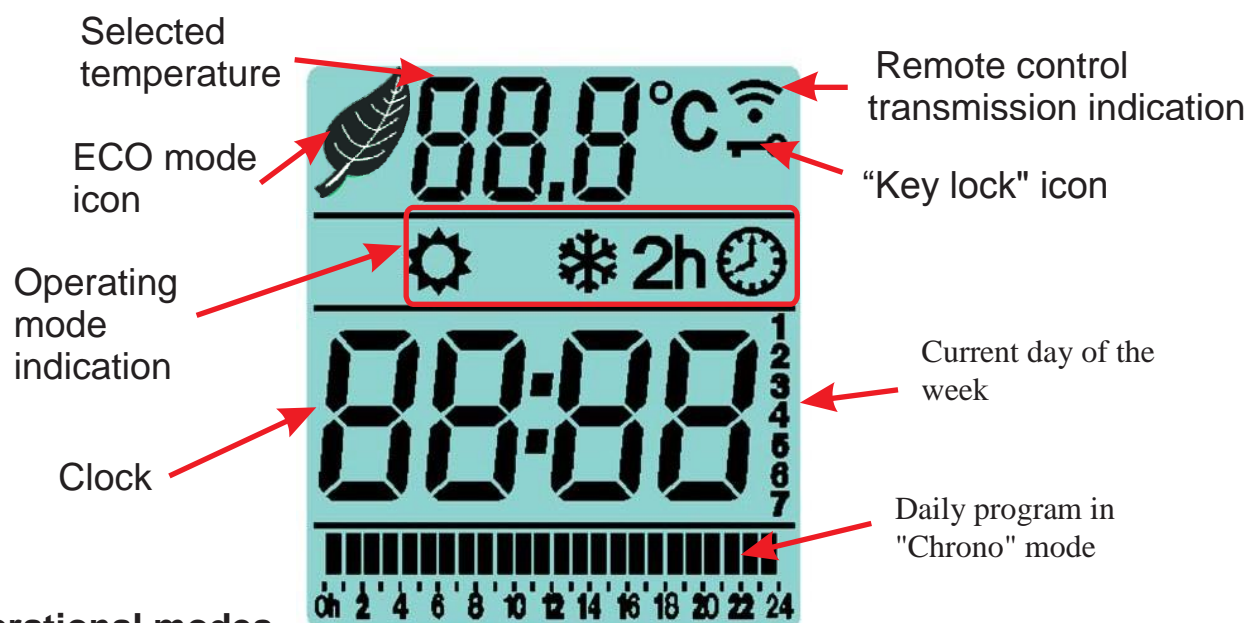

NOTES: - When the device goes into "Stand-by" mode it beeps twice for 0.5s.
- When the device is activated it beeps once for 1s

Turning on the device using the button on the thermostat will directly activate in the "Comfort" mode



2. Operational modes

Press the [Mode] key on the remote control to select the desired operating mode. An icon on the display indicates the selected mode. The mode icons are shown in the following table:

Chrono		Comfort		Antifreeze		Boost 2h	ECO	
--------	---	---------	---	------------	---	----------	-----	---

Comfort Mode

This is the typical operating mode for the device. The "Comfort" temperature corresponds to the desired temperature for the towel radiator.

- Press the [Mode] key until the "Comfort" icon is displayed.
- Set the desired temperature using the [+] and [-] keys. It is possible to choose between the following temperatures: 30°C, 35°C, 40°C, 45°C, 50°C, 55°C, 60°C, 65°C, 70°C.

In "Comfort" mode, the "Mode" LED turns red.

“SMART Program ”

Electronic control for towel radiators

Chrono Mode

This operating mode allows the definition of a weekly program configurable for each day of the week.

To enter into this mode, press the **[Mode]** key until the display shows the "Chrono" icon.

Configuring the hours sequence:

Press the **[Chrono]** key to start the programming procedure.

a) Set the time and day of the week.

- The blinking number shows the day of the week: press **[+]** and **[-]** keys to set the correct day, then press **[Mode]** to confirm.
- Press the **[+]** and **[-]** keys to set the hour then press **[Mode]** to confirm and proceed with the configuration of the minutes.
- For configuring the minutes, repeat the same procedure and confirm with the **[Mode]** key at the end.

b) Configuring the weekly program.

The procedure starts automatically from day 1, and requires specifying the desired temperature (either "Comfort" or "Off") for each hour of the day. This is done by pressing for the current hour either the **[+]** key (for setting the "Comfort" temperature) or the **[-]** key (for disabling the heating element). Once one of the two keys is pressed, the configuration process moves to the following hour (for a total of 24 steps).

The "Comfort" temperature is represented with a filled rectangle while the "Night" temperature is represented with an empty space.

Example

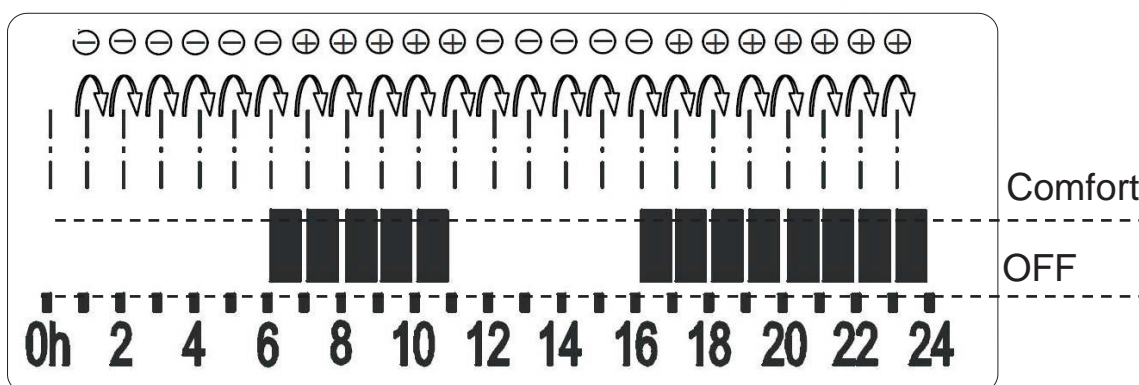

Press **[Mode]** to confirm and proceed repeating the procedure for the following day.

Once the configuration of the seventh day has been completed, the program returns to the previous operating mode.

When the Chrono mode is active, the "On/Stand-by" LED turns amber.

The "Mode" LED turns green during the "Off" period and it turns red during the "Comfort" period.

“SMART Program ”

Electronic control for towel radiators

Antifreeze Mode

In "Antifreeze" mode the device activates the heating element when the towel radiator temperature falls below 7°C. It is suggested to set this operating mode when the room is not occupied for several days.

- Press the **[Mode]** key until the display shows the "Antifreeze" icon.

In "Antifreeze" mode, the "Mode" LED blinks green.

Boost 2h Mode

The "Boost 2h" can be used for quickly warming the room.

-To activate the "Boost 2h" mode, press the corresponding key until the "2h" icon is displayed.

To exit this mode, press either the **[Boost 2h]** key, the **[On/Stand-by]** key or the **[Mode]** key.

For safety reasons, the temperature will be automatically limited to 70°C.

In "Boost 2h" mode, the "Mode" LED blinks red.

Key lock

This function allows locking the buttons of the device to avoid inadvertent modifications of the settings.

All the keys are disabled except the **[On/Stand-by]** button.

Press together the **[Mode]** and **[+]** keys for 3 seconds to activate this mode.

To unlock the buttons repeat the procedure.

ECO Mode

In this mode, you select a preset temperature level of the towel, amounting to 50 ° C (fixed), independently by the other device settings. This function allows reducing the energy consumption.

To activate/deactivate the "ECO" mode, press the corresponding **[ECO]** key 

In "ECO" mode, the "Mode" LED turns red.

“SMART Program ”

Electronic control for towel radiators

Summary table of the "On/Stand-by" LED statuses

Green	The device is in stand-by mode
Red	The device is active
Amber	The device is in “Chrono” mode

Summary table of the "Mode" LED statuses

Blinking Red	"Boost 2h" active. The heating element is powered for 120 minutes.
Blinking Green	"Antfreeze" mode active
Red	Either "Comfort" or “ECO” mode active

NOTES:

- 1) In case of interruption of the power supply, the thermostat returns to the previous operating mode with the exception of “Boost 2h” and “Chrono” modes. The state of the thermostat is saved few seconds after a function is activated.
- 2) The device will beep to confirm the reception of a signal from the remote control.
- 3) “**Mode**” LED blinking amber: Indicates that the probe is defect; the device is deactivated.

Accessory: To allow a mixed usage of the SMART device, connect the T-piece to the towel radiator, insert the SMART device into the vertical manifold of the T-piece and connect the return line of the heating circuit to the orthogonal connector of the T-piece.



Available colours: White; Chromed

Repairs carried out by unauthorized personnel invalidate warranty

The manufacturer reserves the right to make any changes to the product described in this manual, at any time, and without prior warning.



DISPOSAL

This product may not be treated as ordinary household waste. It has to be disposed in proper waste collection sites. In case of replacement it shall be returned to the distributor.

Such an end-of-life treatment of the product will preserve the environment and will reduce consumption of natural resources.

This symbol applied to the present product indicates the obligation to bring it to a proper waste collection site, in order to let it be disposed according to 2002/96 / CE (RAEE - WEEE) directives.